

VHLPX1-15/D

Base Product

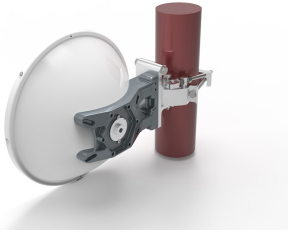

0.3m | 1 ft ValuLine® High Performance Antenna, dual polarized, 14.400–15.350 GHz

Product Classification

Product Type	Microwave antenna
Product Brand	ValuLine®

General Specifications

Antenna Type	VHLPX - ValuLine® High Performance Antenna, dual polarised
Polarization	Dual
Side Struts, Included	0
Side Struts, Optional	0

Dimensions

Diameter, nominal	0.3 m 1 ft
--------------------------	--------------

VHLPX1-15/D

Dimension Drawing

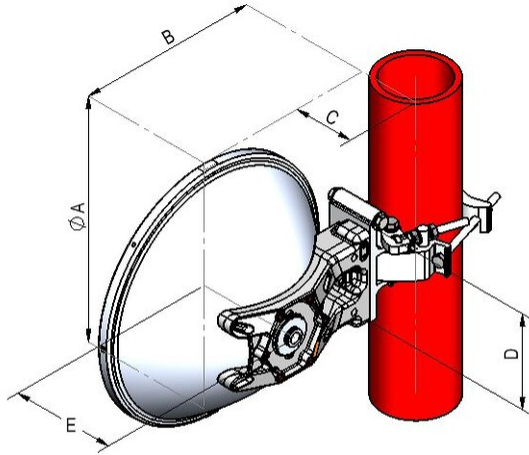

Dimensions in inches (mm)					
Antenna size, ft (m)	A	B	C	D	E
1 (0.3)	15.2(387)	11.3(288)	3.8(97)	6.1(154)	6.5(167)

Electrical Specifications

Operating Frequency Band	14.400 – 15.350 GHz
Gain, Low Band	32.5 dBi
Gain, Mid Band	32.7 dBi
Gain, Top Band	32.9 dBi
Boresite Cross Polarization Discrimination (XPD)	30 dB
Front-to-Back Ratio	60 dB
Beamwidth, Horizontal	4.1 °
Beamwidth, Vertical	4.1 °
Return Loss	17.7 dB
VSWR	1.3
Radiation Pattern Envelope Reference (RPE)	7007D
Electrical Compliance	Brazil Anatel Class 2 ETSI 302 217 Class 3

Mechanical Specifications

Compatible Mounting Pipe Diameter	48 mm–120 mm 1.9 in–4.7 in
Fine Azimuth Adjustment Range	±15°

VHLPX1-15/D

Fine Elevation Adjustment Range	±15°
Wind Speed, operational	180 km/h 111.847 mph
Wind Speed, survival	252 km/h 156.585 mph

Wind Forces at Wind Velocity Survival Rating

Axial Force (FA)	227 N 51.032 lbf
Side Force (FS)	101 N 22.706 lbf
Twisting Moment (MT)	73 N-m 646.104 in lb
Zcg without Ice	28 mm 1.102 in
Zcg with 1/2 in (12 mm) Radial Ice	54 mm 2.126 in
Weight with 1 in (25 mm) Radial Ice	9.4 kg 20.723 lb

VHLPX1-15/D

Wind Forces at Wind Velocity Survival Rating Image



Packaging and Weights

Weight, net

4.08 kg | 8.995 lb

Regulatory Compliance/Certifications

Agency

Classification

ISO 9001:2015

Designed, manufactured and/or distributed under this quality management system

* Footnotes

Operating Frequency Band

Bands correspond with CCIR recommendations or common allocations used throughout the world. Other ranges can be accommodated on special order.

VHLPX1-15/D

Gain, Mid Band	For a given frequency band, gain is primarily a function of antenna size. The gain of Andrew antennas is determined by either gain by comparison or by computer integration of the measured antenna patterns.
Boresite Cross Polarization Discrimination (XPD)	The difference between the peak of the co-polarized main beam and the maximum cross-polarized signal over an angle twice the 3 dB beamwidth of the co-polarized main beam.
Front-to-Back Ratio	Denotes highest radiation relative to the main beam, at $180^\circ \pm 40^\circ$, across the band. Production antennas do not exceed rated values by more than 2 dB unless stated otherwise.
Return Loss	The figure that indicates the proportion of radio waves incident upon the antenna that are rejected as a ratio of those that are accepted.
VSWR	Maximum; is the guaranteed Peak Voltage-Standing-Wave-Ratio within the operating band.
Radiation Pattern Envelope Reference (RPE)	Radiation patterns define an antenna's ability to discriminate against unwanted signals. Under still dry conditions, production antennas will not have any peak exceeding the current RPE by more than 3dB, maintaining an angular accuracy of $\pm 1^\circ$ throughout
Wind Speed, operational	For VHLP(X), SHP(X), HX and USX antennas, the wind speed where the maximum antenna deflection is 0.3 x the 3 dB beam width of the antenna. For other antennas, it is defined as a deflection is equal to or less than 0.1 degrees.
Wind Speed, survival	The maximum wind speed the antenna, including mounts and radomes, where applicable, will withstand without permanent deformation. Realignment may be required. This wind speed is applicable to antenna with the specified amount of radial ice.
Axial Force (FA)	Maximum forces exerted on a supporting structure as a result of wind from the most critical direction for this parameter. The individual maximums specified may not occur simultaneously. All forces are referenced to the mounting pipe.
Side Force (FS)	Maximum side force exerted on the mounting pipe as a result of wind from the most critical direction for this parameter. The individual maximums specified may not occur simultaneously. All forces are referenced to the mounting pipe.
Twisting Moment (MT)	Maximum forces exerted on a supporting structure as a result of wind from the most critical direction for this parameter. The individual maximums specified may not occur simultaneously. All forces are referenced to the mounting pipe.